

RN 6040 58.75" x 39" x 21"

AirBath option will add 1" to height of unit

Premium Thermal Cast Acrylic

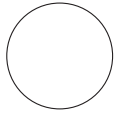

white

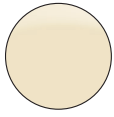

bone

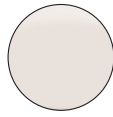

biscuit

Cut-Out

1" to inside dimension around the rim

Operating Capacity

39 Gallons

Shipping Weight:

Soaker - 164 lbs

Whirlpool - 194 lbs

Hydro-Massage System

4 Premium Power-Flow Adjustable Jets

1 Lumbar Ease-Flow Adjustable Jets

Optional Features

- Skirt
Not Available
- Cast Acrylic Nailing Flange
Not Available
- In-Line Heater
Yes

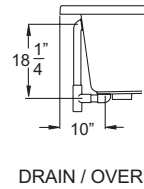
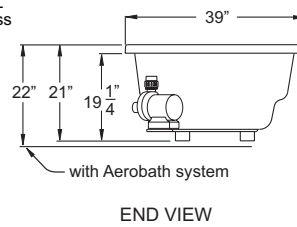
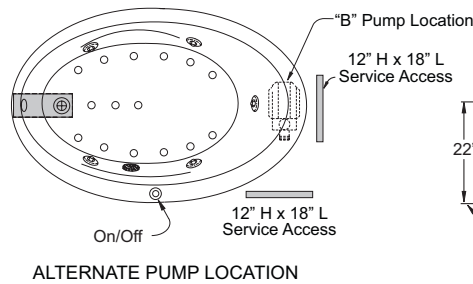
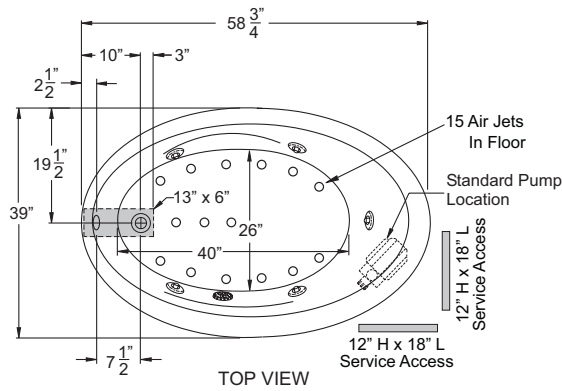

CONTRACTOR ADVANTAGE
soaker tubs | whirlpools | air tubs



soaker tub



whirlpool



airtub

