

SB6036 – ICON SHOWER PANS

60 x 36 x 3 inches



FEATURES

- ArmorCore™ slip resistant, textured bottom
- Center drain
- Low 3" threshold
- Integrated weep holes
- Sloped threshold ensures water containment
- Pre-leveled legs, no mortar bed required
- Sleek minimalist design
- AcrylX™ applied acrylic surface
- Lifetime limited warranty

OPTIONS

- Brass drain assembly and cover

COLOR OPTIONS

Standard

White



PRAXIS



SB6036

60 x 36 x 3
inches

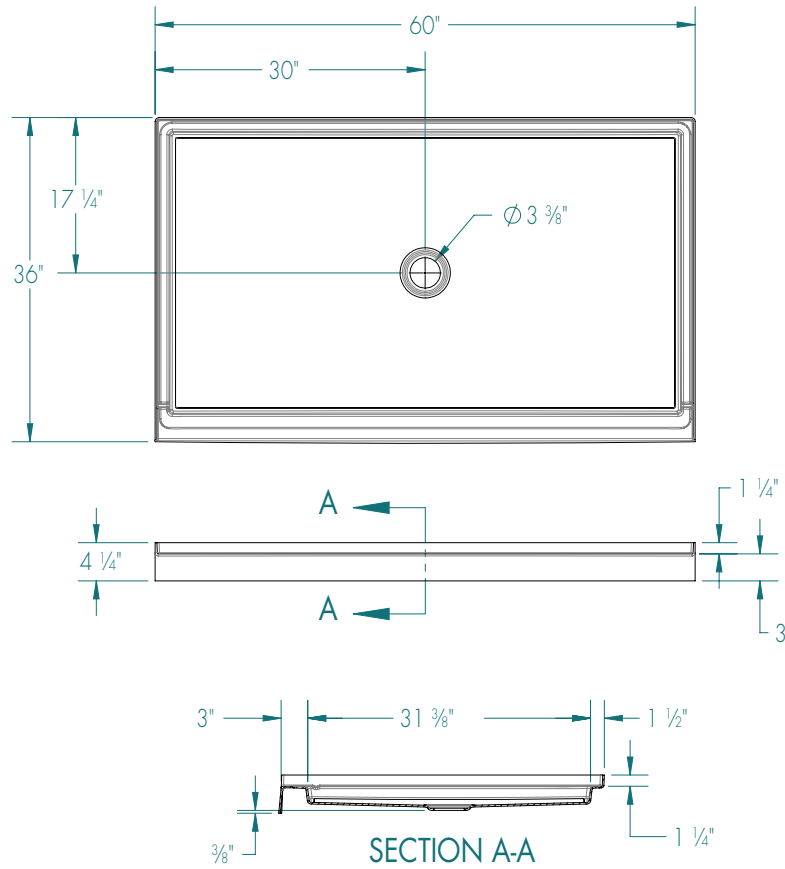

FEATURES Dimensional Tolerance $\pm 3/16"$. Dimensions needed for site preparation should be measured from the unit. Manufacturer assumes no responsibility for preparatory work.

Model #	Material	Drain	Net Wt. lbs.	Pkg. Wt. lbs.
Shower Pan #SB6036	AcrylX™	Center	77	—

DIMENSIONS

Specifications	inches
Width: Overall / Net	60
Depth: Overall / Net	36
Height: Overall / Net	4 1/4 / 3
Enclosure Opening	—
Skirt Height	3
Drain Rough-In (from Back Wall)	17 1/4
Drain Rough-In (from Side Wall)	30
Drain: Diameter / Clearance	3 3/8 / 3/8

FRAMING DIMENSIONS inches

Type	D Depth	W Width	H Height	A	B	C
Alcove	36	60	—	Box Out	30	17 1/4

