

# RN 7040 71.5" x 40.5" x 20.5"

AirBath option will add 1" to height of unit

Premium Thermal Cast Acrylic

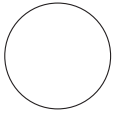

white

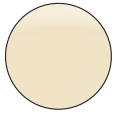

bone

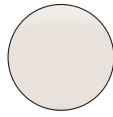

biscuit

Cut-Out

1" to inside dimension around the rim

Operating Capacity

69 Gallons

Shipping Weight:

Soaker - 129 lbs

Whirlpool - 159 lbs

Hydro-Massage System

4 Premium Power-Flow Adjustable Jets

1 Lumbar Ease-Flow Adjustable Jets

2 Foot Ease-Flow Adjustable Jets

Optional Features

- Skirt  
Not Available
- Cast Acrylic Nailing Flange  
Not Available
- In-Line Heater  
Yes

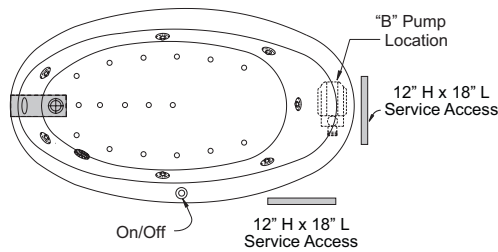
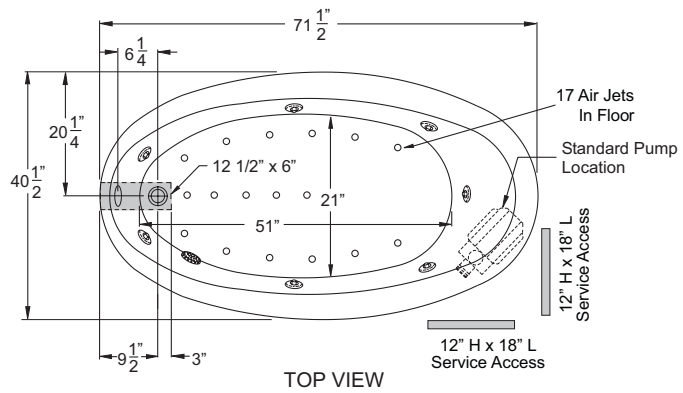

ALTERNATE PUMP LOCATION

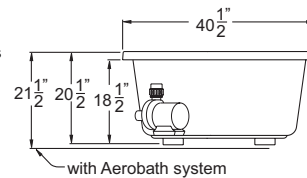

END VIEW

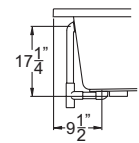

DRAIN / OVERFLOW

CONTRACTOR ADVANTAGE  
soaker tubs | whirlpools | air tubs



soaker tub



whirlpool



airtub

