

# RN RIO 6042 60" x 42" x 21"

AirBath option will add 1" to height of unit

Premium Thermal Cast Acrylic

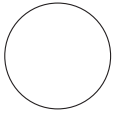

white

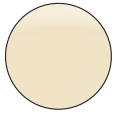

bone

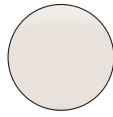

biscuit

Cut-Out  
58" x 40"

Operating Capacity  
59 Gallons

Shipping Weight:  
Soaker - 164 lbs  
Whirlpool - 194 lbs

Hydro-Massage System  
4 Premium Power-Flow Adjustable Jets  
2 Lumbar Ease-Flow Adjustable Jets

Optional Features

- Skirt  
Factory installed - Aventura  
Field or factory installed - Deco
- Cast Acrylic Nailing Flange  
No
- In-Line Heater  
Yes

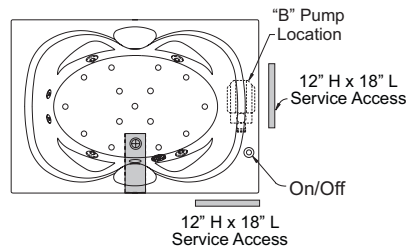
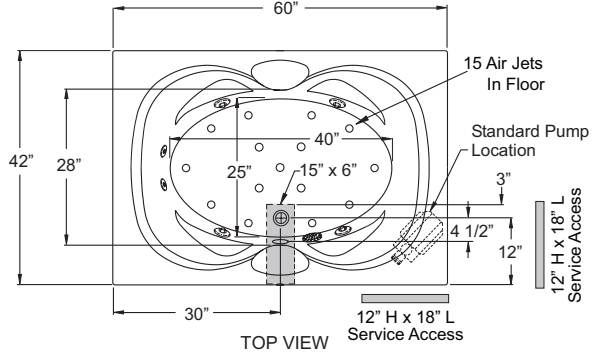

ALTERNATE PUMP LOCATION

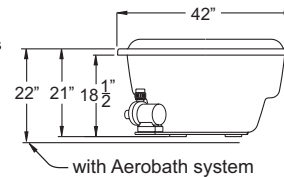

END VIEW

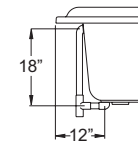

DRAIN / OVERFLOW

CONTRACTOR ADVANTAGE  
soaker tubs | whirlpools | air tubs



soaker tub



whirlpool



airtub

